

**FLUKE®**

**787**

ProcessMeter

**Product Overview**

November 2000 Rev. 1, 12/01

© 2000, 2001 Fluke Corporation. All rights reserved. Printed in U.S.A.  
All product names are trademarks of their respective companies.



## Quick Reference Information

⚠ Read Safety Information in the *787 Users Manual*.

### Measure Pushbuttons

- $\rightarrow$ , ac or dc A
- Starts recording, shows minimum, maximum, and average.
- Locks on next range. Hold 1 second for auto range.
- Toggles TouchHold® or suspends MIN MAX recording.
- When in  $\Omega$ , selects continuity.
- Zeros display for relative reading.
- When in ac V measure, selects frequency counter.

### Output mA Pushbuttons

- FINE Up/down 0.001 mA
- COARSE Up/down 0.1 mA
- % STEP Up/down to next 25% step

### Output mA Choices:

Press

- Slow ramp, 0% → 100% → 0%, 40 seconds
- Fast ramp, 0% → 100% → 0%, 15 seconds
- Stair-step ramp, 0, 25, 50, 75, 100%, pause 5 seconds at each step

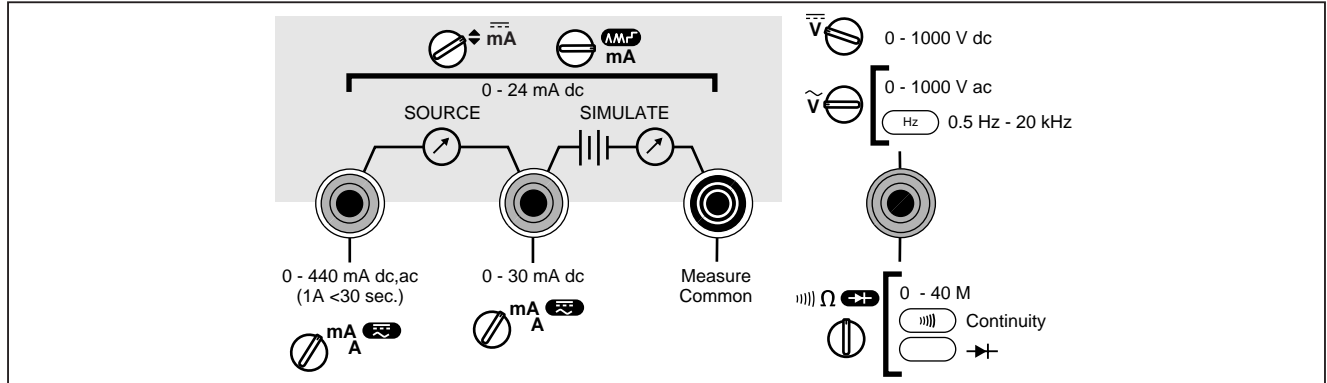

## **LIMITED WARRANTY & LIMITATION OF LIABILITY**

This Fluke product will be free from defects in material and workmanship for three years from the date of purchase. This warranty does not cover disposable batteries or damage from accident, neglect, misuse or abnormal conditions of operation or handling. Resellers are not authorized to extend any other warranty on Fluke's behalf. To obtain service during the warranty period, send your defective meter to the nearest Fluke Authorized Service Center with a description of the problem.

THIS WARRANTY IS YOUR ONLY REMEDY. NO OTHER WARRANTIES, SUCH AS FITNESS FOR A PARTICULAR PURPOSE, ARE EXPRESSED OR IMPLIED. FLUKE IS NOT LIABLE FOR ANY SPECIAL, INDIRECT, INCIDENTAL OR CONSEQUENTIAL DAMAGES OR LOSSES, ARISING FROM ANY CAUSE OR THEORY.

Since some states or countries do not allow the exclusion or limitation of an implied warranty or of incidental or consequential damages, this limitation of liability may not apply to you.

Fluke Corporation  
P.O. Box 9090  
Everett, WA  
98206-9090 USA

Fluke Europe B.V.  
P.O. Box 1186  
5602 B.D. Eindhoven  
The Netherlands

# ***ProcessMeter***

## ***Introduction***

### **⚠ Warning**

**Read “Safety Information” before you use the meter.**

Your Fluke 787 ProcessMeter™ (referred to as “the meter”) is a handheld, battery-operated tool for measuring electrical parameters and supplying steady or ramping current to test process instruments. It has all the features of a digital multimeter, plus current output capability.

Your meter is shipped with a Flex-Stand™ holster, one set of TL75 test leads, one set of AC70A Alligator Clips, this manual, and a CD-ROM containing the Users Manual. If the meter is damaged or something is missing, contact the place of purchase immediately.

Contact your Fluke distributor for information about DMM accessories. To order replacement parts or spares, see Table 7 near the end of this manual.

## ***Accessing the Users Manual***

The *787 Users Manual* is available on the 787 CD-ROM shipped with your ProcessMeter.

## Contacting Fluke

To order accessories, receive operating assistance, or get the location of the nearest Fluke distributor or Service Center, call:

USA : 1-888-99-FLUKE (1-888-993-5853)

Canada: 1-800-36-FLUKE (1-800-363-5853)

Europe: +31 402-678-200

Japan: +81-3-3434-0181

Singapore: +65-738-5655

Anywhere in the world: +1-425-446-5500

Address correspondence to:

Fluke Corporation

P.O. Box 9090,

Everett, WA 98206-9090

USA

Fluke Europe B.V.

P.O. Box 1186,

5602 BD Eindhoven

The Netherlands

Or visit us on the World Wide Web: [www.fluke.com](http://www.fluke.com)

## Safety Information

The meter complies with IEC1010-1, ANSI/ISA S82.01-1994 and CAN/CSA C22.2 No. 1010.1-92 Overvoltage Category III. Use the meter only as specified in this manual, otherwise the protection provided by the meter may be impaired.

A **Warning** identifies conditions and actions that pose hazard(s) to the user; a **Caution** identifies conditions and actions that may damage the meter or the equipment under test.

International symbols used on the meter and in this manual are explained in Table 1.

### **Warning**

**To avoid possible electric shock or personal injury:**

- **Do not use the meter if it is damaged. Before you use the meter, inspect the case. Look for cracks or missing plastic. Pay particular attention to the insulation surrounding the connectors.**

- **Make sure the battery door is closed and latched before you operate the meter.**
- **Remove test leads from the meter before you open the battery door.**
- **Inspect the test leads for damaged insulation or exposed metal. Check test leads continuity. Replace damaged test leads before you use the meter.**
- **Do not use the meter if it operates abnormally. Protection may be impaired. When in doubt, have the meter serviced.**
- **Do not operate the meter around explosive gas, vapor, or dust.**
- **Use only a single 9V battery, properly installed in the meter case, to power the meter.**
- **When servicing the meter, use only specified replacement parts.**

### **Caution**

**To avoid possible damage to meter or to equipment under test:**













**Disconnect the power and discharge all high-voltage capacitors before testing resistance or continuity.**

**Use the proper jacks, function, and range for your measurement or sourcing application.**

To protect yourself, adhere to the following guidelines:

- Use caution when working above 30V ac rms, 42V ac pk, or 60V dc. Such voltages pose a shock hazard.
- When using the probes, keep your fingers behind the finger guards on the probes.
- Connect the common test lead before you connect the live test lead. When you disconnect test leads, disconnect the live test lead first.

Table 1. International Symbols

Symbol	Meaning	Symbol	Meaning
	Alternating current		Earth ground
	Direct current		Fuse
	Alternating or direct current		Conforms to European Union directives
	Refer to the manual for information about this feature.		Conforms to relevant Canadian Standards Association directives
	Battery		Double insulated
	Meets Underwriters' Laboratories safety requirements		Inspected and licensed by TÜV Product Services
CAT III	Overvoltage (Installation) Category III, Pollution Degree 2 per IEC1010-1 refers to the level of Impulse Withstand Voltage protection provided. Typical locations include; Mains, wall outlets, main distribution levels connected closer to the supply system but less than the primary supply system (CAT IV).		



## Getting Acquainted with the Meter

To become familiar with the features and functions of the meter, study the following figures and tables.

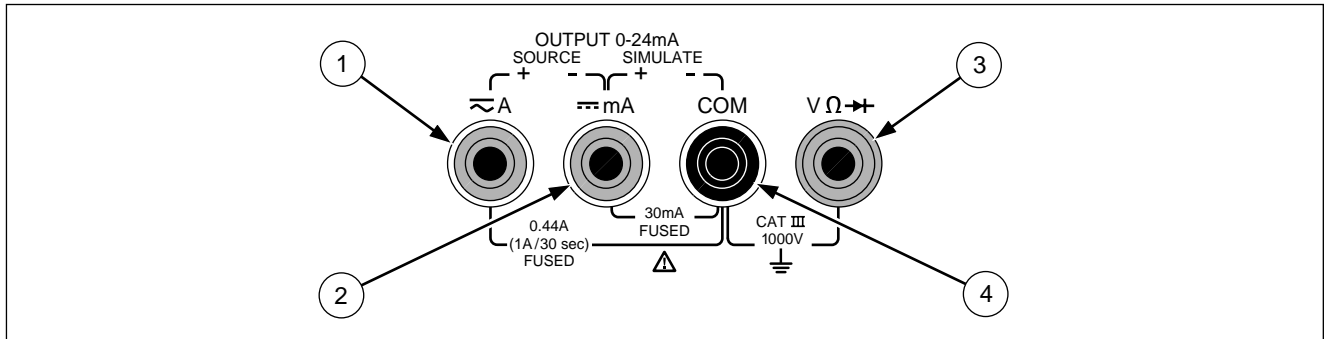

- Figure 1 and Table 2 describe the input/output jacks.
- Figure 2 and Table 3 describe the input functions you get with the first five rotary switch positions.
- Figure 3 and Table 4 describe the output functions you get with the last two rotary switch positions.
- Figure 4 and Table 5 describe the functions of the pushbuttons.
- Figure 5 and Table 6 explain what all the elements of the display indicate.

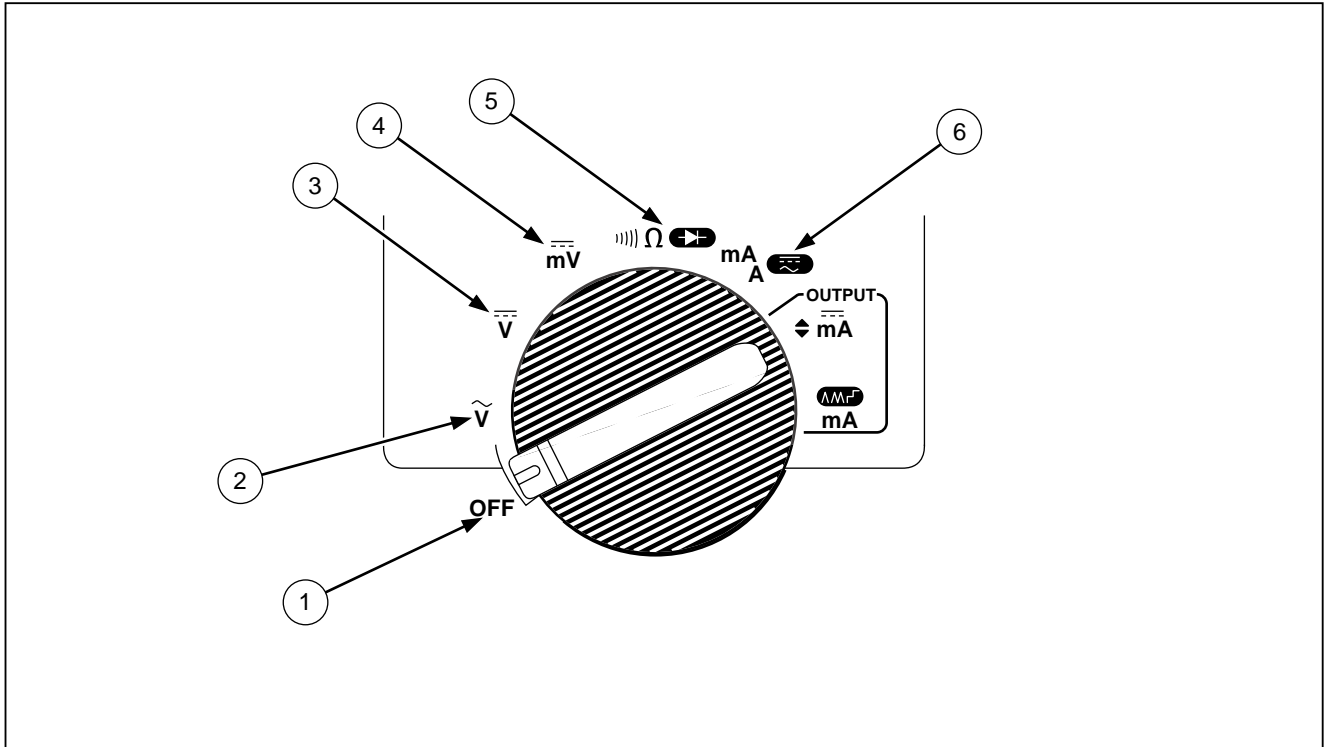

**Figure 1. Input/Output Jacks**

ee001f.eps

Table 2. Input/Output Jacks











Item	Jack	Measurement Functions	Source Current Function	Simulate Transmitter Function
①	 A	Input for current to 440 mA continuous. (1A for up to 30 seconds.) Fused with a 440 mA fuse.	Output for dc current to 24 mA.	
②	 mA	Input for current to 30 mA. Fused with a 440 mA fuse.	Common for dc current output to 24 mA.	Output for transmitter simulation to 24 mA. (Use in series with an external loop supply.)
③	 V $\Omega$ $\rightarrow$	Input for voltage to 1000V, $\Omega$ , continuity, and diode test.		
④	COM	Common for all measurements.		Common for transmitter simulation to 24 mA. (Use in series with an external loop supply.)

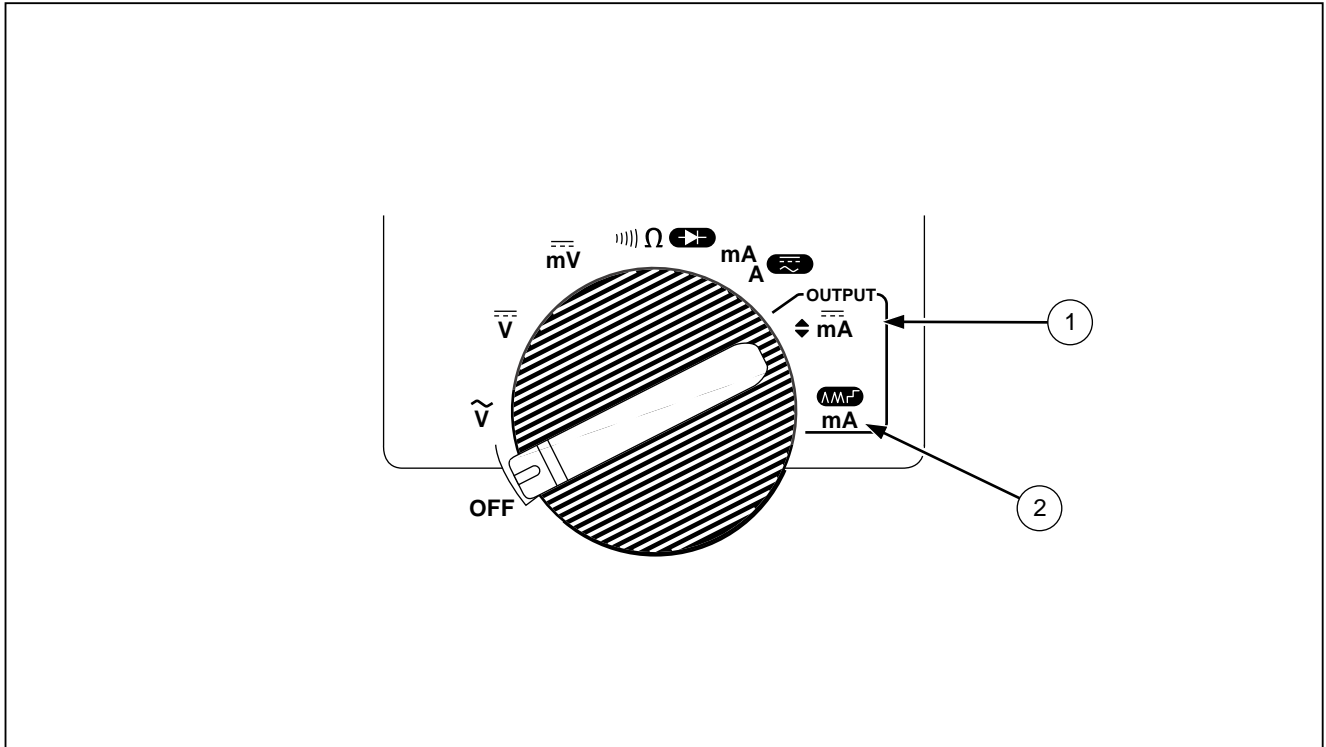

**Figure 2. Rotary Switch Positions for Measurements**

ee002f.eps

Table 3. Rotary Switch Positions for Measurements

No.	Position	Function(s)	Pushbutton Actions
①	OFF	Meter off	
②	V ~	Default: measure ac V  Frequency counter	 Selects a MIN, MAX, or AVG action (see pg. 18)  Selects a fixed range (hold 1 second for auto range)  Toggles TouchHold  Toggles relative reading (sets a relative zero point)
③	== V	Measure dc V	Same as above
④	== mV	Measure dc mV	Same as above
⑤	 Ω 	Default: measure Ω  for continuity BLUE  test	Same as above, except diode test has only one range
⑥	mA A 	<i>High test lead in</i> ~ A: measure A dc BLUE selects ac <i>High test lead in</i> == mA: measure mA dc	Same as above, except there is only one range for each input jack position, 30 mA or 1A

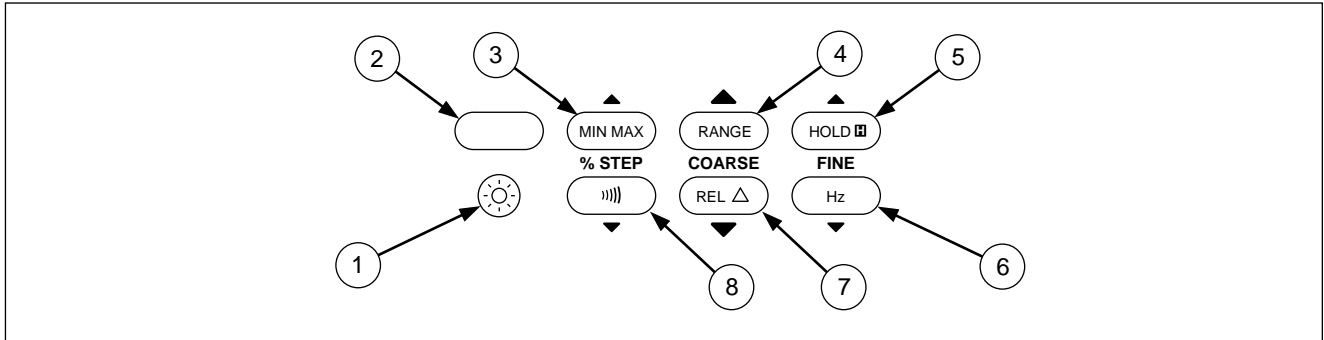

**Figure 3. Rotary Switch Positions for mA Output**

ee008.eps

Table 4. Rotary Switch Positions for mA Output

No.	Position	Default Function	Pushbutton Actions
①	OUTPUT ◆ mA	<i>Test leads in</i> <b>SOURCE:</b> Source 0% mA  <i>Test leads in</i> <b>SIMULATE:</b> Sink 0% mA	% STEP ▲ or ▼: Adjusts output up or down to the next 25% step  COARSE ▲ or ▼: Adjusts output up or down 0.1 mA  FINE ▲ or ▼: Adjusts output up or down 0.001 mA
②	OUTPUT mA 	<i>Test leads in</i> <b>SOURCE:</b> Source repeating 0% -100%-0% slow ramp (∧)  <i>Test leads in</i> <b>SIMULATE:</b> Sink repeating 0% -100%-0% slow ramp (∧)	BLUE cycles through: <ul style="list-style-type: none"> <li>• Fast repeating 0% -100% - 0% ramp (∧ on display)</li> <li>• Repeating 0% -100% - 0% ramp in 25% steps (┌ on display)</li> <li>• Slow repeating 0% -100% - 0% ramp (∧ on display)</li> </ul>









ee003f.eps

**Figure 4. Pushbuttons**

**Table 5. Pushbuttons**

No.	Pushbutton	Function(s)
①		Toggles the backlight
②	 (BLUE)	Rotary switch in mA A  position and test lead plugged into  A jack: Toggles between ac and dc ampere measure Rotary switch in  Ω  position: Selects diode test function () Rotary switch in OUTPUT mA  position: Cycles through <ul style="list-style-type: none"> <li>• Slow repeating 0% -100% - 0% ramp ( on display)</li> <li>• Fast repeating 0% -100% - 0% ramp ( on display)</li> <li>• Repeating 0% -100% - 0% ramp in 25% steps ( on display)</li> </ul>

Table 5. Pushbuttons (cont.)

No.	Pushbutton	Function(s)
③		<i>Measuring:</i> Selects a MIN, MAX, or AVG action <i>mA Output:</i> Adjusts mA output up to the next higher 25% step
④		<i>Measuring:</i> Selects a fixed range (hold for 1 second for auto range) <i>mA Output:</i> Adjusts output up 0.1 mA
⑤		<i>Measuring:</i> Toggles TouchHold, or in MIN MAX recording, suspends recording <i>mA Output:</i> Adjusts output up 0.001 mA
⑥	FINE 	<i>Measuring:</i> Toggles between frequency counter and ac voltage measurement functions <i>mA Output:</i> Adjusts output down 0.001 mA
⑦	COARSE 	<i>Measuring:</i> Toggles relative reading (sets a relative zero point) <i>mA Output:</i> Adjusts output down 0.1 mA
⑧	% STEP 	<i>Measuring:</i> Toggles between $\Omega$ measure and continuity functions <i>mA Output:</i> Adjusts mA output down to the next lower 25% step



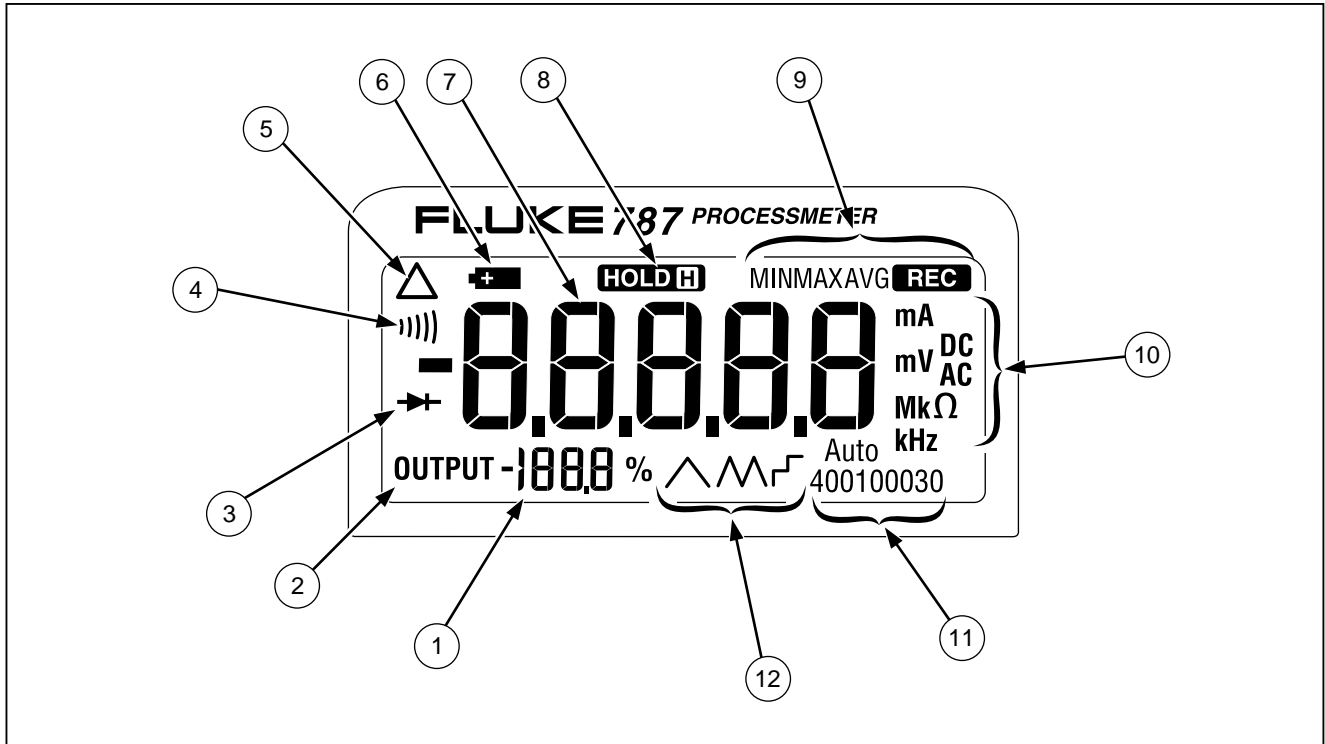







Figure 5. Elements of the Display

ee004f.eps

Table 6. Display

No.	Element	Meaning
①	Percentage display	Shows the mA measured value or output level in %, in a 0-20 mA or 4-20 mA scale (change scales with power-up option)
②	OUTPUT	Lights when mA output (source or simulate) is active
③		Lights in diode test function
④	)))	Lights in continuity function
⑤	△	Lights when relative reading is on
⑥		Lights when the battery is low
⑦	Numerals	Show the input or output value
⑧		Lights when TouchHold is on
⑨	MINMAXAVG 	<p>MIN MAX recording status indicators:</p> <p>MIN means the display is showing the minimum recorded value.</p> <p>MAX means the display is showing the maximum recorded value.</p> <p>AVG means the display is showing the average value since starting recording (up to about 35 hours continuous recording time).</p> <p> means MIN MAX recording is on.</p>

**Table 6. Display (cont.)**

No.	Element	Meaning
⑩	<b>mA, DC, mV, AC, M or kΩ, kHz</b>	Show the input or output units and multipliers associated with the numerals
⑪	<b>Auto 400100030</b>	Range status indicators: <b>Auto</b> means autoranging is on. The number plus the unit and multiplier indicate the active range.
⑫	∧ ∞ ⌋	One of these lights in mA ramping or step output (rotary switch position mA  ): ∧ means slow continuous 0% - 100% - 0% ramping. ∞ means fast continuous 0% - 100% - 0% ramping. ⌋ means ramping in 25% steps.

## Replacing the Battery

### Warning

To avoid electrical shock, remove test leads from the meter before you open the battery door.

Close and latch the battery door before you use the meter.

Remove test leads from the meter before you open the battery door.

Replace the battery as follows. Refer to Figure 6. Use an alkaline 9V battery, type ANSI/NEDA 1604A or IEC 6LR61.

1. Remove the test leads and set the rotary switch to OFF.
2. With a standard blade hand screwdriver, turn each battery door screw counterclockwise so that the slot is parallel with the screw picture molded into the case.
3. Lift off the battery door.

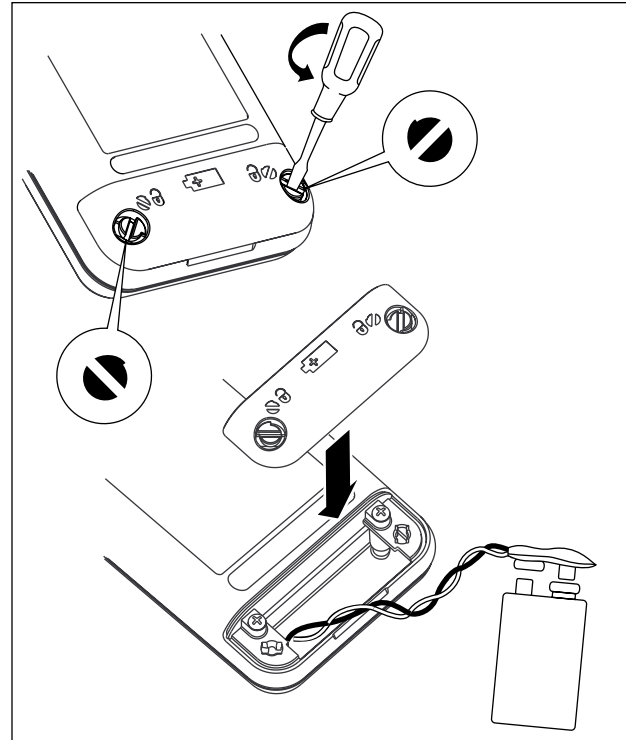

ee007f.eps



Figure 6. Replacing the Battery

## Replacing a Fuse

### **Warning**

**To avoid personal injury or damage to the meter, use only the specified replacement fuse, 440 mA 1000V fast-blow, Fluke PN 943121.**

Both current input jacks are fused with a separate 440 mA fuse. To determine if a fuse is blown:

1. Turn the rotary switch to mA A .
2. Plug the black test lead into COM, and the red test lead into  A.
3. Using an ohmmeter, check the resistance between the meter test leads. If the resistance is about  $1\Omega$ , the fuse is good. An open means the fuse is blown.
4. Move red test lead to  mA.
5. Using an ohmmeter, check the resistance between the meter test leads. If the resistance is about  $14\Omega$ , the fuse is good. An open means the fuse is blown.

If a fuse is blown, replace it as follows. Refer to Figure 7 as necessary:

1. Remove the test leads from the meter and turn the rotary switch to OFF.
2. Remove the battery door.
3. Remove the three Phillips-head screws from the case bottom and turn the case over.
4. Gently lift the bottom of the front of the case (nearest the input/output jacks) until the top unsnaps from the rear half of the case.
5. Replace the blown fuse with the exact type specified: 440 mA 1000V fast-blow fuse, Fluke PN 943121. Both fuses are the same type.
6. Make sure the rotary switch is in the OFF position.
7. Fit the top of case together, engaging the two snaps (item ①). Make sure that the gasket is properly seated.
8. Close the case and reinstall the three screws.
9. Replace the battery door.

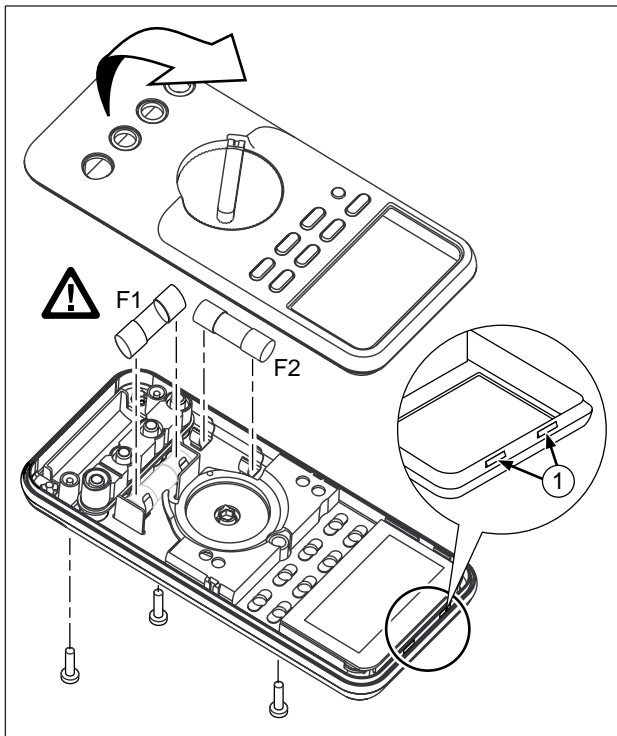

Figure 7. Replacing a Fuse

## Replacement Parts and Accessories

### ⚠ Warning

To avoid personal injury or damage to the meter, use only the specified replacement fuse, 440 mA 1000V fast-blow, Fluke PN 943121.

### Note

When servicing the meter, use only the replacement parts specified here.

Replacement parts and some accessories are shown in Figure 8 and listed in Table 7. Many more DMM accessories are available from Fluke. For a catalog, contact your nearest Fluke distributor.

To find out how to order parts or accessories use the telephone numbers or addresses shown on page 1 of this manual.

**Table 7. Replacement Parts**

Item	Description	Fluke PN or Model no.	Quantity
BT1	9V battery, ANSI/NEDA 1604A or IEC 6LR61	614487	1
CG81Y	Holster, Yellow	CG81G	1
△ F1, 2	Fuse, 440 mA, 1000V fast-blow	943121	2
MP85	Case top	619962	1
MP86	Case bottom	619939	1
H2, 3, 4	Case screw	832246	3
MP89, 90	Non-skid foot	824466	2
MP8	O-ring for input/output receptacle	831933	1
MP92	Battery door	619947	1
H5, 6	Battery door fasteners	948609	2
S1	Keypad	646932	1
TL75	Standard test lead set	TL75	1
AC70A	Alligator clips for use with TL75 test lead set	AC70A	1
TL20	Industrial test lead set	TL20	Option
TM1	Product Overview Manual	1586717	1
TM2	Users Manual (CD-ROM)	1586721	1
TM3	Calibration Manual (not shown)	641891	Option

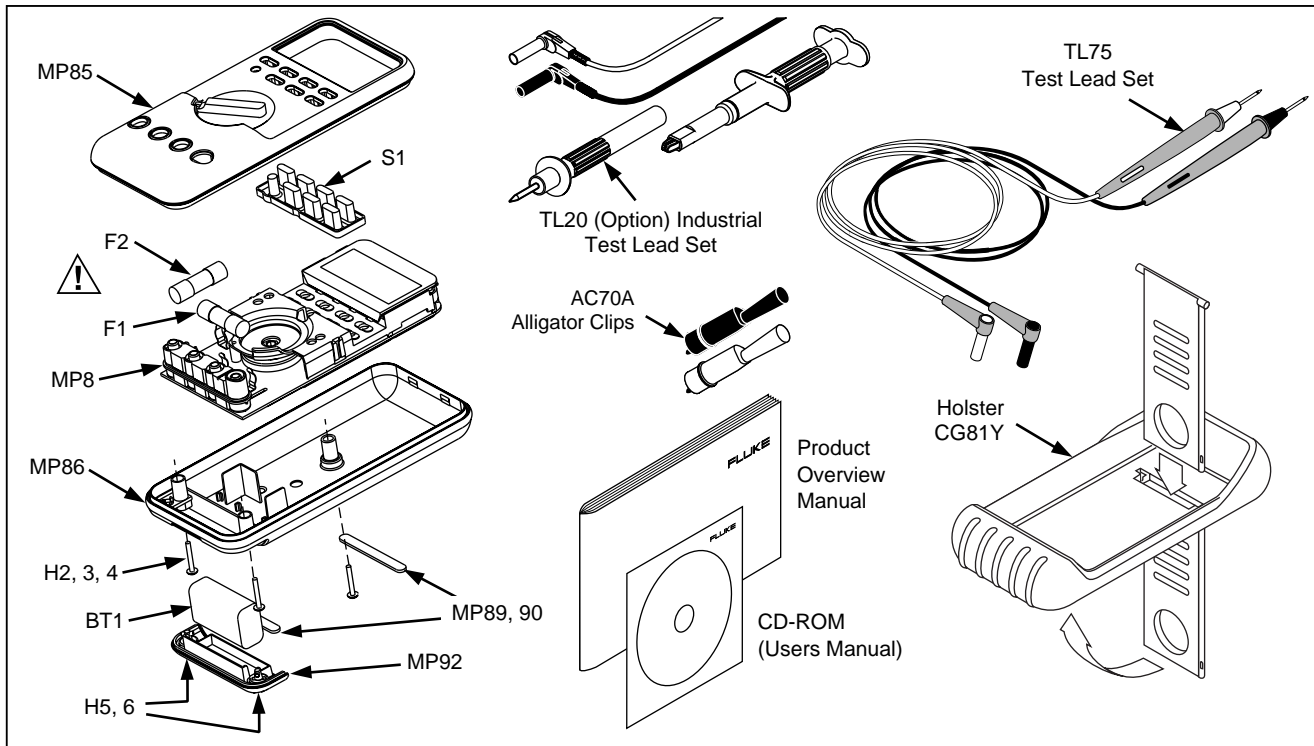

ee015c.eps

Figure 8. Replacement Parts



## Specifications

All specifications apply from +18°C to +28°C unless stated otherwise.

All specifications assume a 5 minute warmup period.

The standard specification interval is 1 year.

*Note*

*“Counts” means number of increments or decrements of the least significant digit.*

### DC Volts Measurement

Range (V dc)	Resolution	Accuracy, $\pm$ (% of Reading + Counts)
4.000	0.001V	0.1% + 1
40.00	0.01V	0.1% + 1
400.0	0.1V	0.1% + 1
1000	1V	0.1% + 1

*Input impedance: 10 M $\Omega$  (nominal), < 100 pF*  
*Normal mode rejection ratio: >60 dB at 50 Hz or 60 Hz*  
*Common mode rejection ratio: >120 dB at dc, 50 Hz, or 60 Hz*  
*Overvoltage protection: 1000V*

**DC Millivolts Measurement**

Range (mV dc)	Resolution	Accuracy (% of Reading + Counts)
400.0	0.1 mV	0.1% + 1

**AC Volts Measurement**

Range (ac)	Resolution	Accuracy, $\pm$ (% of Reading + Counts)		
		50 Hz to 60 Hz	45 Hz to 200 Hz	200 Hz to 500 Hz
400.0 mV	0.1 mV	0.7% + 4	1.2% + 4	7.0% + 4
4.000V	0.001V	0.7% + 2	1.2% + 4	7.0% + 4
40.00V	0.01V	0.7% + 2	1.2% + 4	7.0% + 4
400.0V	0.1V	0.7% + 2	1.2% + 4	7.0% + 4
1000V	1V	0.7% + 2	1.2% + 4	7.0% + 4

*Specifications are valid from 5% to 100% of amplitude range.*

*AC conversion: true rms*

*Maximum crest factor: 3*

*For non-sinusoidal waveforms, add  $\pm$ (2% reading + 2% f.s.) typical*

*Input impedance: 10 M $\Omega$  (nominal), < 100 pF, ac-coupled*

*Common mode rejection ratio: >60 dB at dc, 50 Hz, or 60 Hz*

### AC Current Measurement

Range 45 Hz to 2 kHz	Resolution	Accuracy, $\pm$ (% of Reading + Counts)	Typical Burden Voltage
1.000A (Note)	0.001A	1% + 2	1.5V/A

*Note: 440 mA continuous, 1A 30 seconds maximum*

*Specifications are valid from 5% to 100% of amplitude range.*

*AC conversion: true rms*

*Maximum crest factor: 3*

*For non-sinusoidal waveforms, add  $\pm$ (2% reading + 2% f.s.) typical*

*Overload protection 440 mA, 1000V fast-blow fuse*

### DC Current Measurement

Range	Resolution	Accuracy, $\pm$ (% of Reading + Counts)	Typical Burden Voltage
30.000 mA	0.001 mA	0.05% + 2	14 mV/mA
1.000A (Note)	0.001A	0.2% + 2	1.5V/A

*Note: 440 mA continuous, 1A 30 seconds maximum*

*Overload protection: 440 mA, 1000V fast-blow fuse*

**Ohms Measurement**

<b>Range</b>	<b>Resolution</b>	<b>Measurement Current</b>	<b>Accuracy, <math>\pm</math>(% of Reading + Counts)</b>
400.0 $\Omega$	0. 1 $\Omega$	220 $\mu$ A	0.2% + 2
4.000 k $\Omega$	0.001 k $\Omega$	59 $\mu$ A	0.2% + 1
40.00 k $\Omega$	0.01 k $\Omega$	5.9 $\mu$ A	0.2% + 1
400.0 k $\Omega$	0.1 k $\Omega$	590 nA	0.2% + 1
4.000 M $\Omega$	0.001 M $\Omega$	220 nA	0.35% + 3
40.00 M $\Omega$	0.01 M $\Omega$	22 nA	2.5% + 3
<i>Overload protection: 1000V</i> <i>Open circuit voltage: &lt;3.9V</i>			

**Frequency Counter Accuracy**

Range	Resolution	Accuracy, $\pm$ (% of Reading + Counts)
199.99 Hz	0.01 Hz	0.005% + 1
1999.9 Hz	0.1 Hz	0.005% + 1
19.999 kHz	0.001 kHz	0.005% + 1

*Display updates 3 times/second at >10 Hz*

**Frequency Counter Sensitivity**

Input Range	Minimum Sensitivity (rms Sinewave) 5 Hz to 5 kHz*
1 V	0.1 V
4 V	1 V
40 V	3 V
400 V	30 V
1000 V	300 V

\* Usable 0.5 Hz to 20 kHz with reduced sensitivity.

### **Diode Test and Continuity Test**

**Diode test indication:** display voltage drop: 0.2 mA nominal test current at 0.6V: 2.4V full scale, accuracy  $\pm(2\% + 1 \text{ count})$

**Continuity test indication:** continuous audible tone for test resistance  $<100\Omega$

**Open circuit voltage:**  $<3.9\text{V}$

**Short circuit current:** 1.2 mA typical

**Overload protection:** 1000V rms

### **DC Current Output**

#### **Source mode:**

Span: 0 mA or 4 mA to 20 mA, with overrange to 24 mA

Accuracy: 0.05% of span

Compliance voltage: 12V with battery voltage  $>8.5\text{V}$

#### **Simulate Mode:**

Span: 0 mA or 4 mA to 20 mA, with overrange to 24 mA

Accuracy: 0.05% of span

Loop voltage: 24V nominal, 30V maximum, 15V minimum

Compliance voltage: 21V for 24V supply

Burden voltage:  $<3\text{V}$

### **General Specifications**

**Maximum voltage applied between any jack and earth ground:** 1000V

**Storage temperature:**  $-40^{\circ}\text{C}$  to  $60^{\circ}\text{C}$

**Operating temperature:**  $-20^{\circ}\text{C}$  to  $55^{\circ}\text{C}$

**Operating altitude:** 2000 meters maximum

**Temperature coefficient:** 0.05 x specified accuracy per  $^{\circ}\text{C}$  for temperatures  $<18^{\circ}\text{C}$  or  $>28^{\circ}\text{C}$

**Accuracy adders for use in RF Fields:** In an RF field of 3V/m, change the accuracy specifications as follows:

For DC Millivolts Measurement, add 0.03% of range

For AC Volts Measurement, add 0.37% of range

For DC Current Measurement, 30.000 mA range, add 0.14% of range

For DC Current Output, add 0.02% of span

Accuracy for all meter functions is not specified in RF fields  $> 3\text{V/m}$ .

**Relative humidity:** 95% up to  $30^{\circ}\text{C}$ , 75% up to  $40^{\circ}\text{C}$ , 45% up to  $50^{\circ}\text{C}$ , and 35% up to  $55^{\circ}\text{C}$

**Vibration:** Random 2g, 5 to 500 Hz

**Shock:** 1 meter drop test

**Water and dust protection:** Complies with IEC529 IP52  
(normal operating vacuum used for dust test)

**Safety:** Complies with IEC1010-1, ANSI/ISA S82.01-1994 and CAN/CSA C22.2 No. 1010.1-92 Overvoltage Category III.

**Power requirements:** Single 9V battery (ANSI/NEDA 1604A or IEC 6LR61)

**Size:** 32 mm H x 87 mm W x 187 mm L (1.25 in H x 3.41 in W x 7.35 in L);

With holster and Flex-Stand: 52 mm H x 98 mm W x 201 mm L (2.06 in H x 3.86 in W x 7.93 in L)

**Weight:** 369 g (13 oz);

With holster and Flex-Stand: 638 g (22.5 oz)

**Certifications:** CSA, UL, TÜV

